

CRIMP QUALITY GUIDELINES

CRIMP CROSS SECTION CHARACTERISTICS

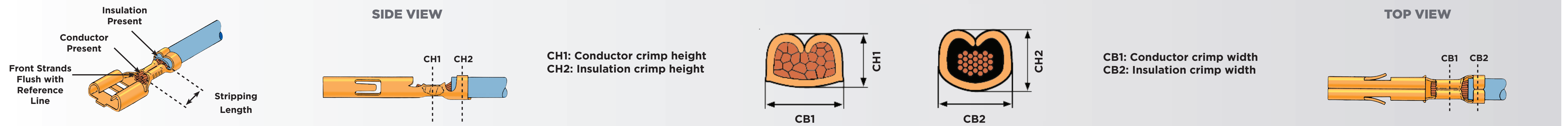

Good Crimp Quality

WIRE CRIMP

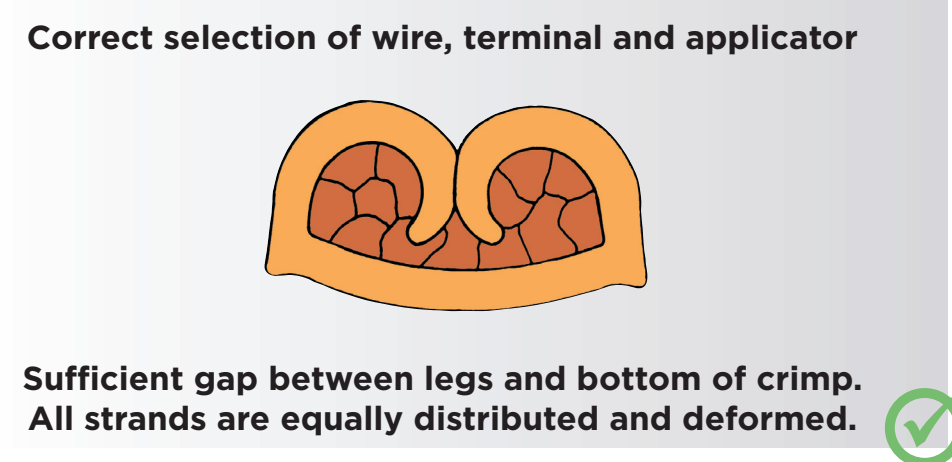
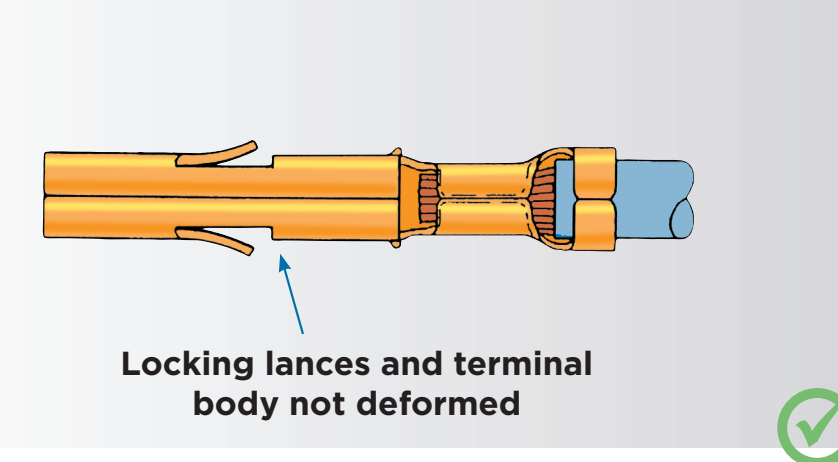
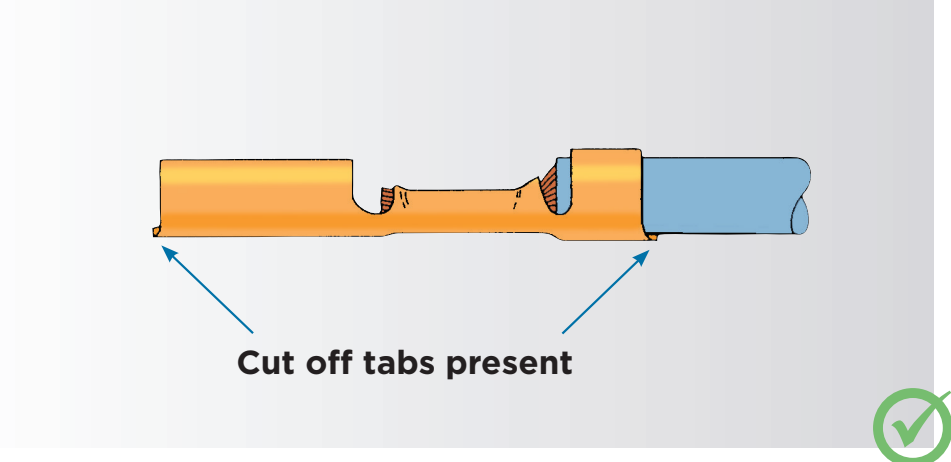
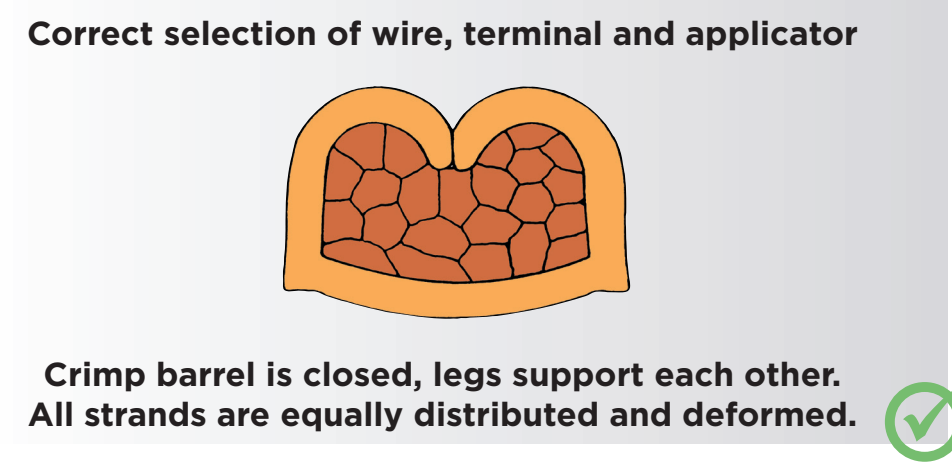
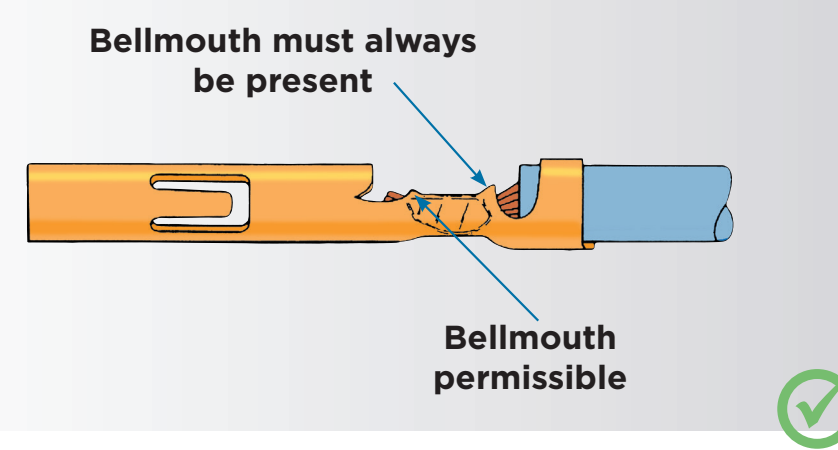
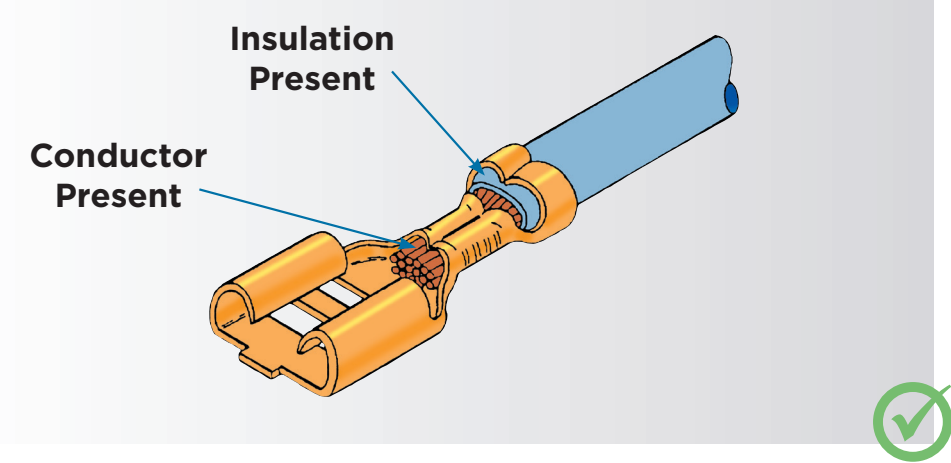

INSULATION CRIMP 'F'

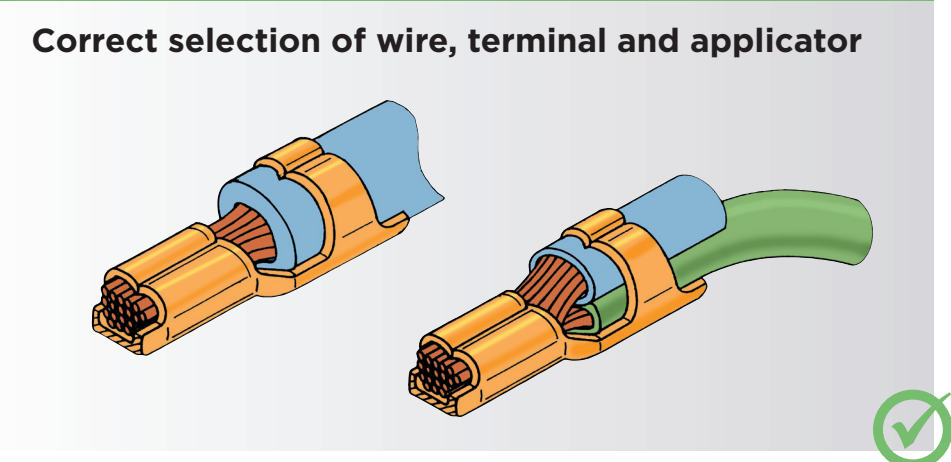

INSULATION CRIMP 'OVERLAP'

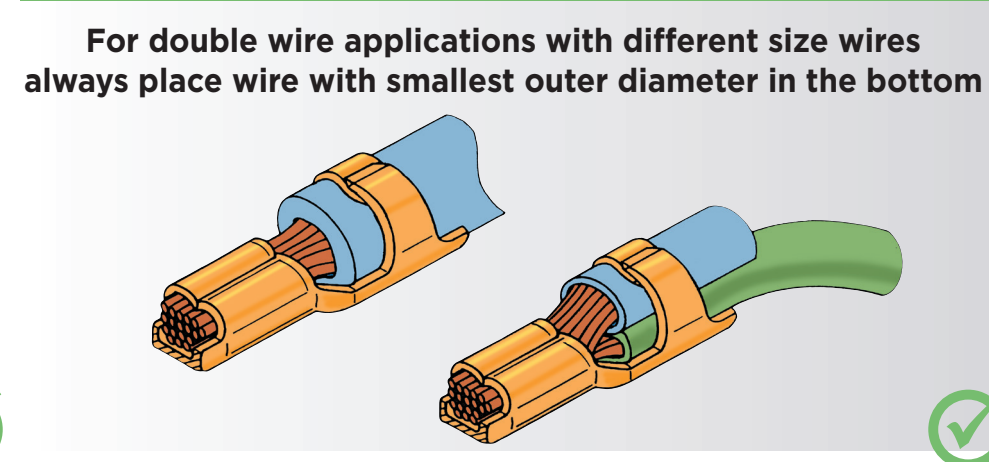

INSULATION CRIMP 'WRAP OVER'

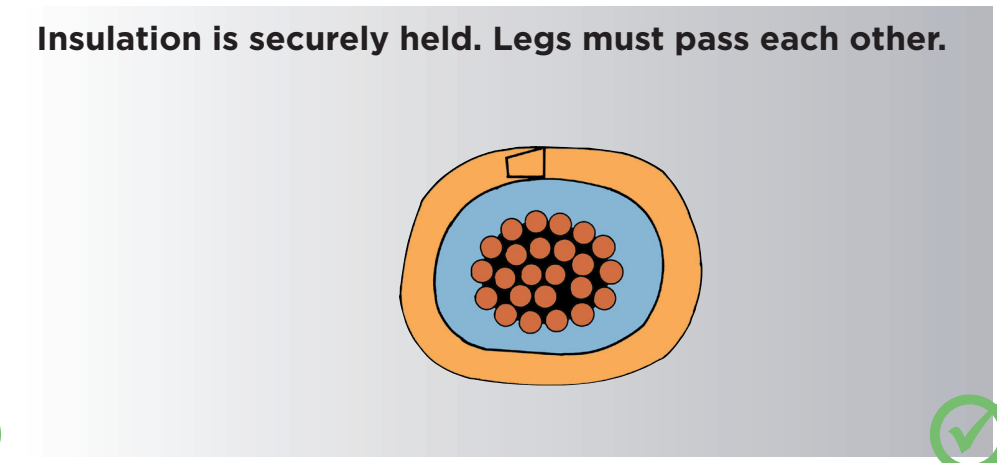
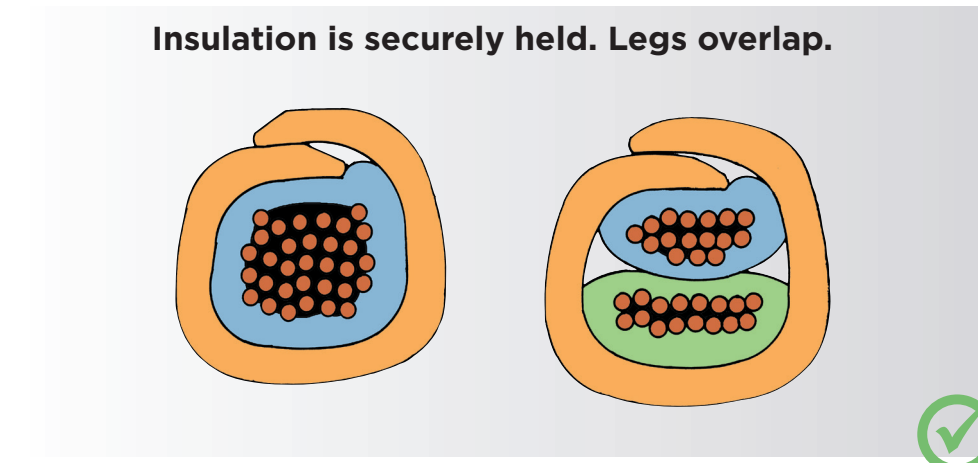
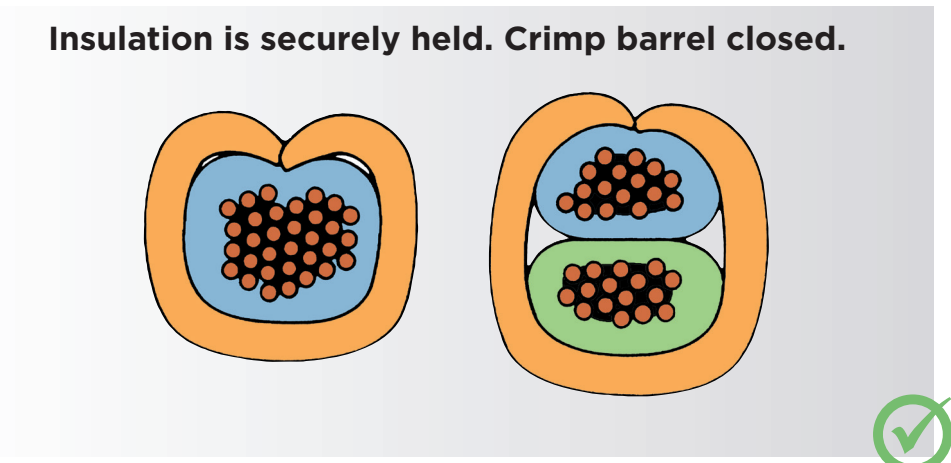
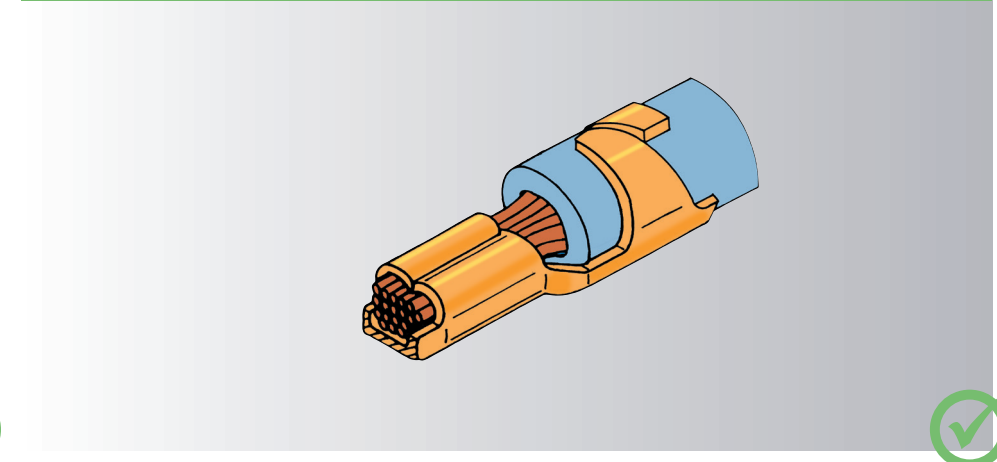

Incorrect Crimp Quality

WIRE CRIMP

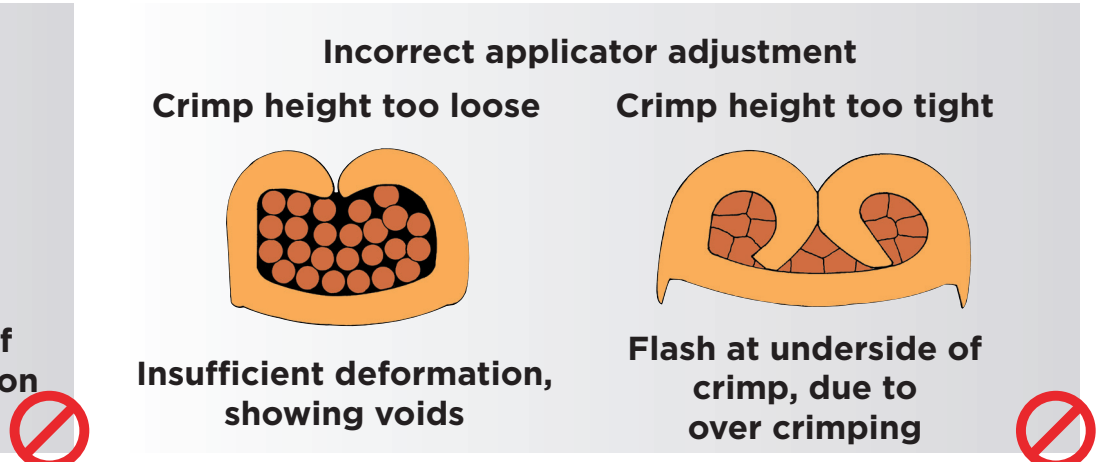
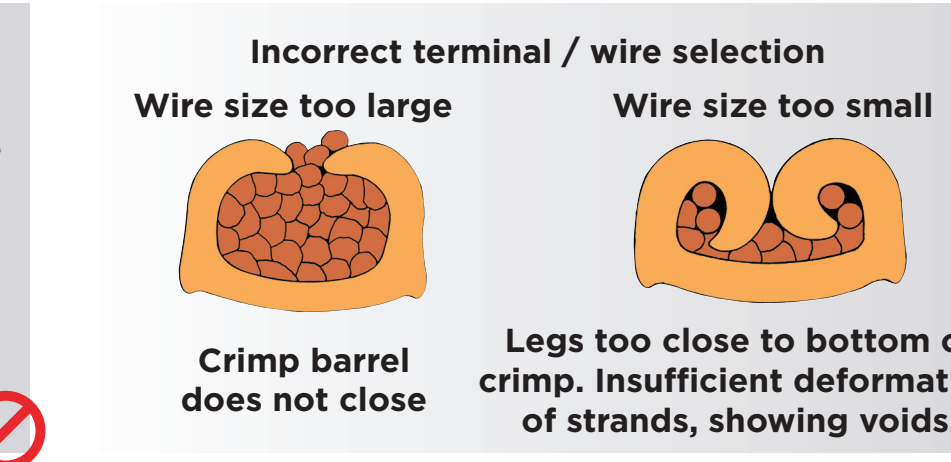
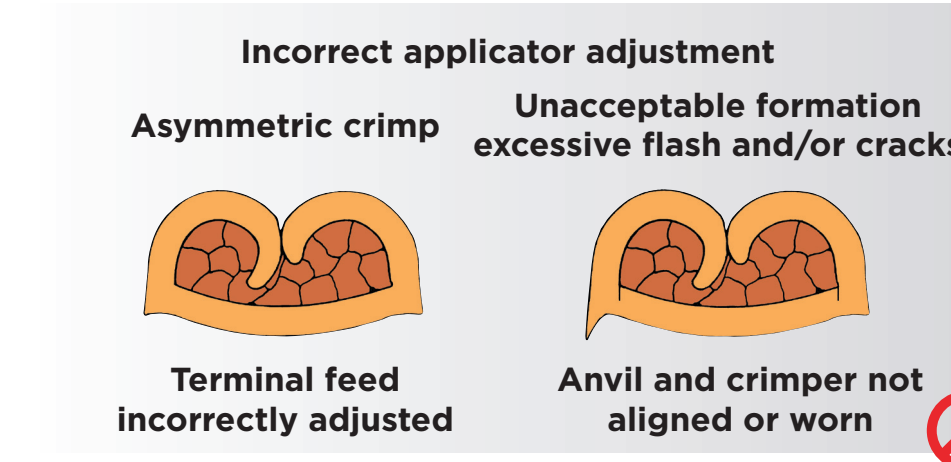
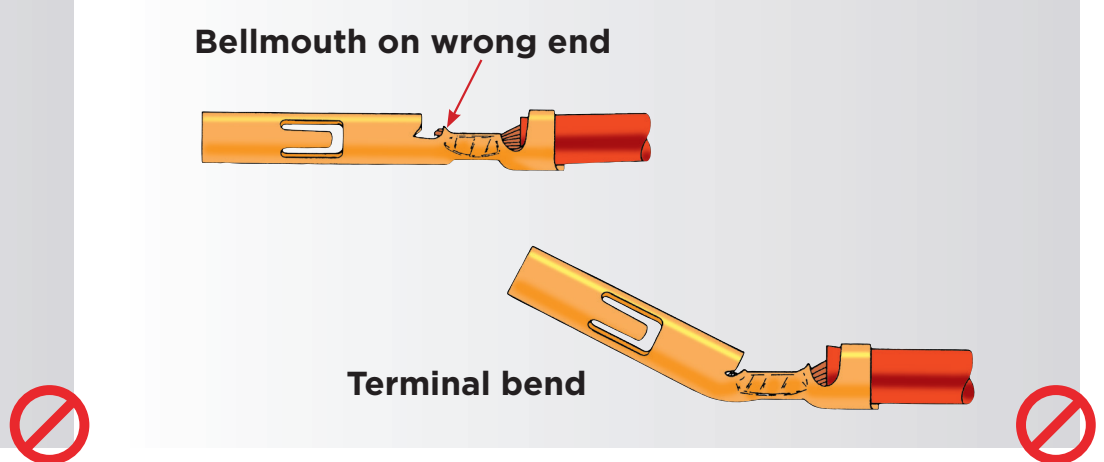
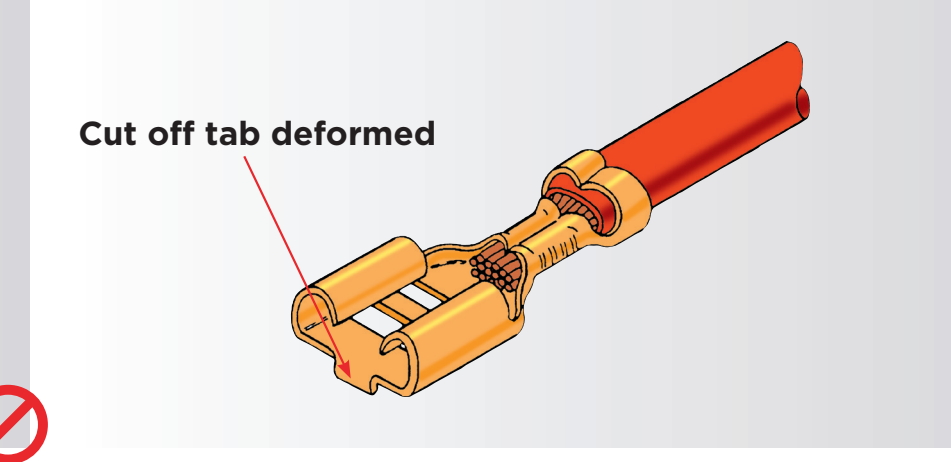
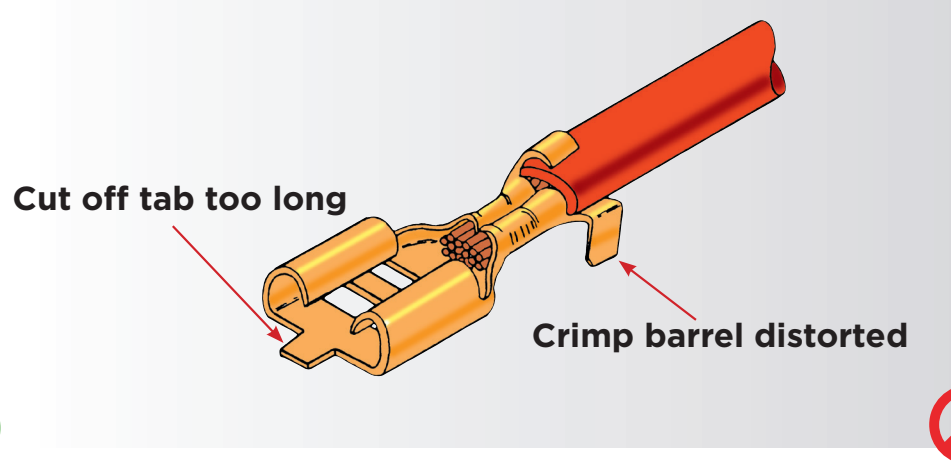
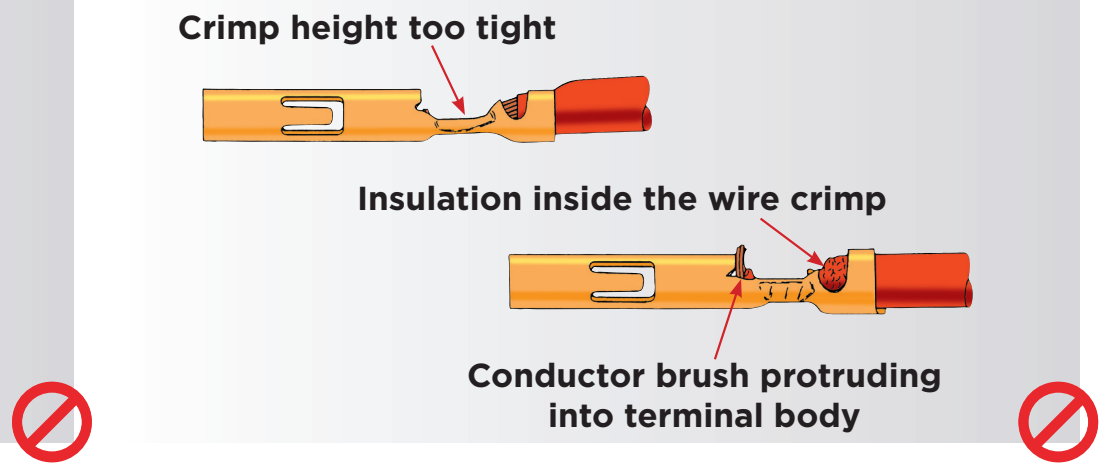
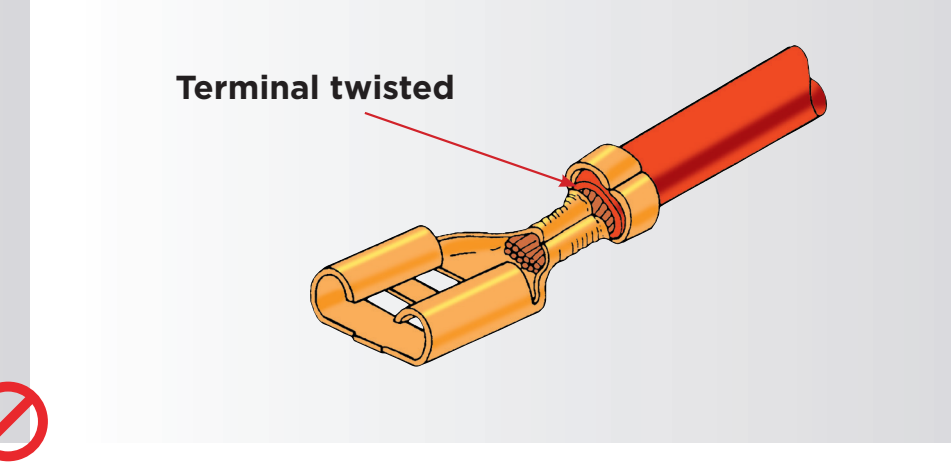
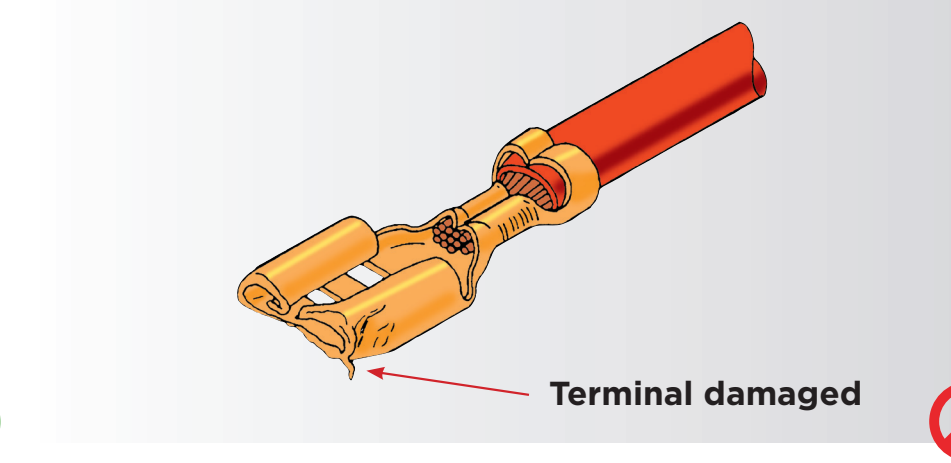

INSULATION CRIMP 'F'

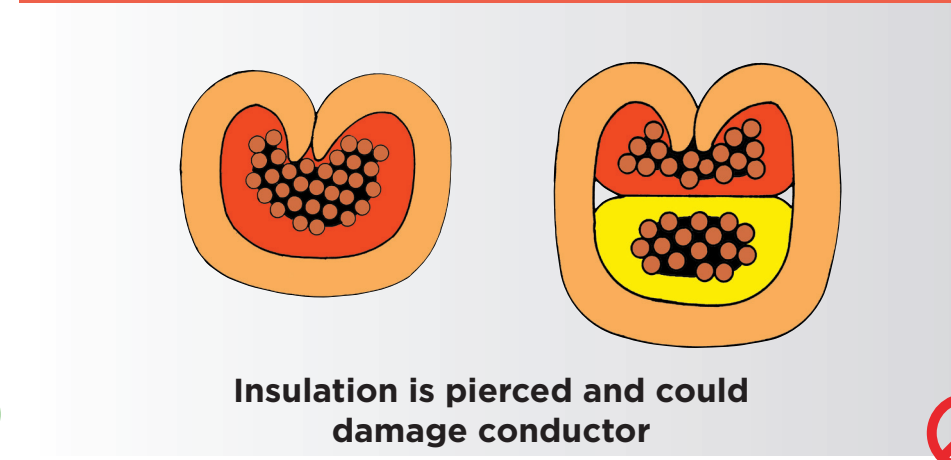

INSULATION CRIMP 'OVERLAP'

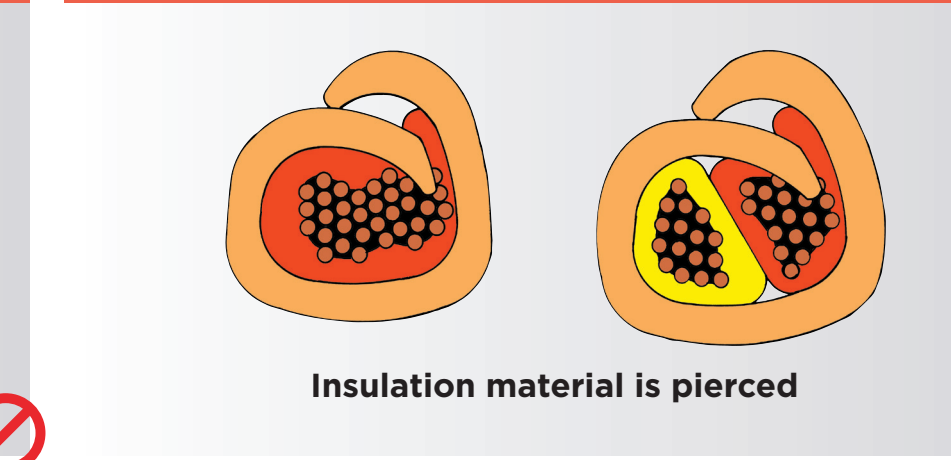

INSULATION CRIMP 'WRAP OVER'

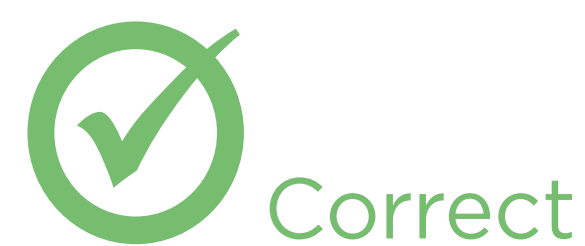
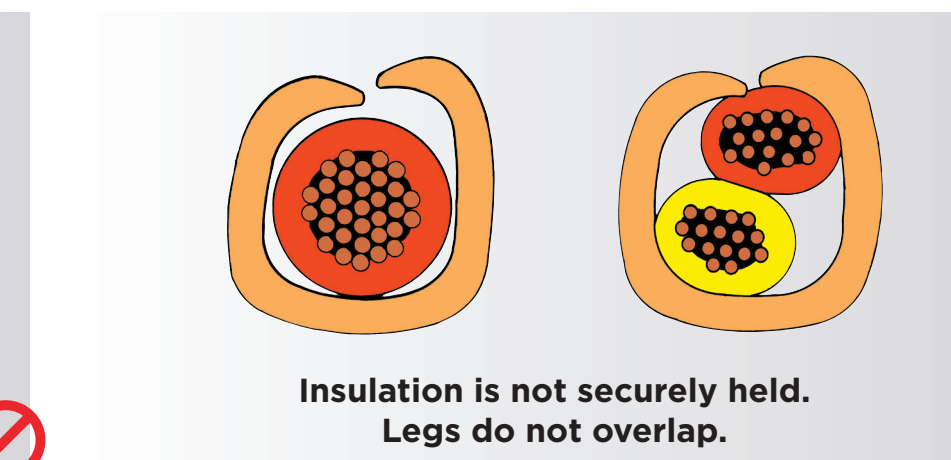
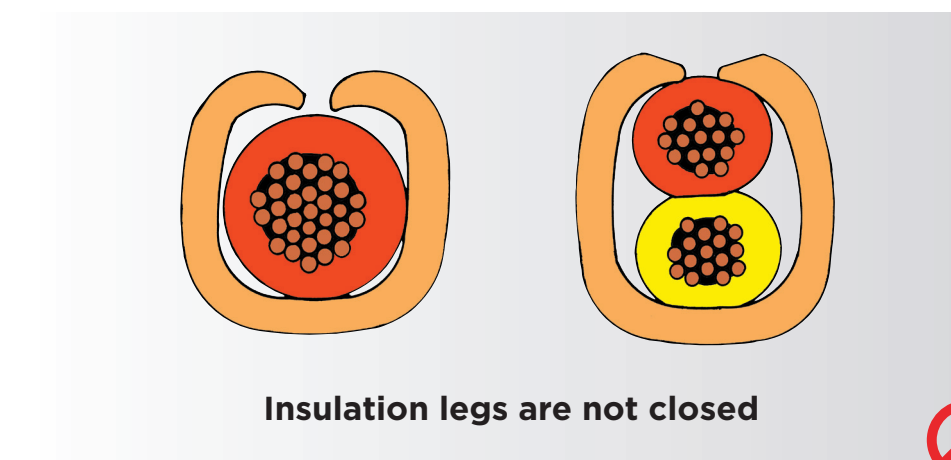
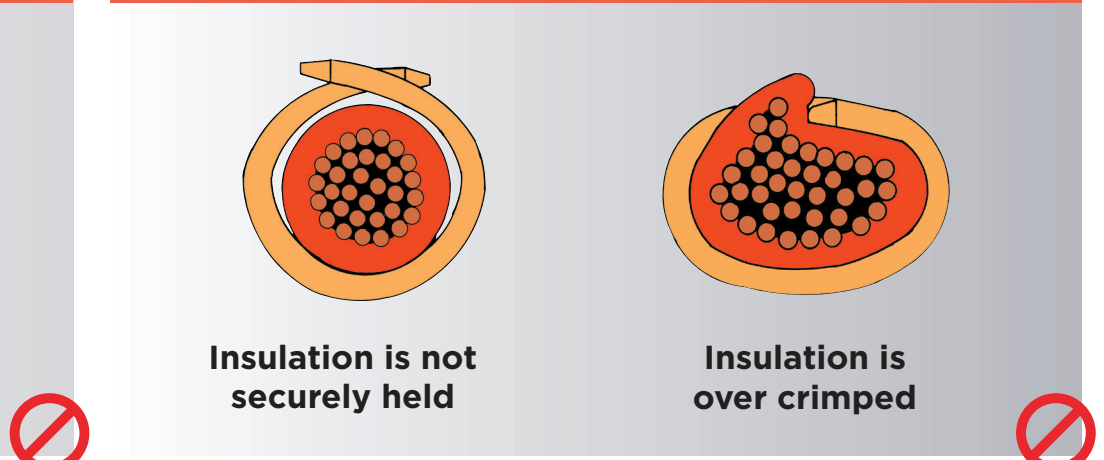

All figures are schematic depictions. In every case, relevant product and application specification take precedence.

The above images of crimp failures are only shown as examples and are by no means exhaustive of all possible failures. In every case, relevant product and application specification take precedence.